



VACON NXP AND NXC  
SUPERLATIVE PERFORMANCE

**VACON**  
DRIVEN BY DRIVES

## THE DYNAMIC CHOICE

The Vacon NXP is a state-of-art AC drive for use in all applications where reliability, dynamic performance, precision and power are required.

The quality and reliability of a machine or process is in most cases the result of the precise, dynamic control of AC motors. The Vacon NXP has been designed to provide the best possible control under all circumstances, ensuring high operational quality and availability for the entire lifetime of a system.

A forerunner in designing and manufacturing AC drives, Vacon has developed innovative solutions and leading-edge technology for demanding applications and high power ranges.

By bringing these solutions to customers, the Vacon NXP opens up new opportunities and helps them create the best and highly innovative products and achieve the most challenging targets.

### Features

- Full power and voltage range
- High number of options
- Wide set of applications adapts the Vacon NXP to virtually any need
- Controls induction and permanent magnet motors
- Dynamic open and closed loop vector control
- Complete range of communications and I/O options
- Fast drive-to-drive communication

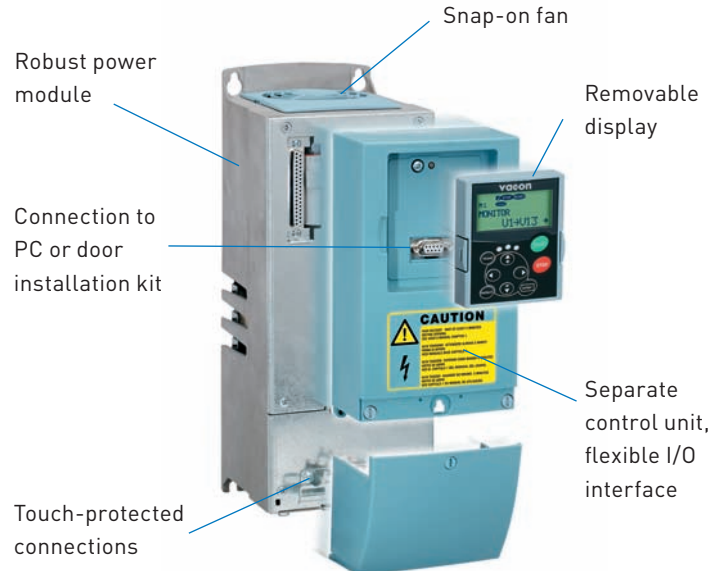

### FR4—FR9



## OUTSTANDING FLEXIBILITY

The Vacon NXP offers, in addition to its control characteristics, a wide choice of products and cabinets for the varying needs in the high-power range.

Three models are available to meet various customer needs as follows:

- Vacon NXP IP21/IP54 wall-mounted or standalone drives for installation wherever there is space available
- Vacon NXP high-power IP00 drive modules for installation in the customer's cabinet
- Vacon NXC robust cabinet drive with maximum flexibility and a wide range of options



**VACON NXP  
DRIVE MODULES**



**VACON NXP  
STANDALONE DRIVES**



**VACON NXC  
CABINET DRIVES**

## WALL-MOUNTED VACON NXP

For the lower power range, Vacon NXP drives are available in a compact IP21 or IP54 enclosure. One of the most compact and complete drives on the market, it has all necessary components integrated a single enclosure.

The wall-mounted units are equipped with internal EMC filtering, and the power electronics are integrated into an all-metal frame. The smaller frame sizes (FR4-FR6) have an integrated brake chopper as standard, and the 380-500 V units can be equipped with an integrated brake resistor. The larger frames (FR7-FR12) can be equipped with an integrated brake chopper as option.

### Mains voltage 208—240 V, 50/60 Hz, 3~

AC drive type	Loadability					Motor shaft power		Frame size	Dimensions and weight W*H*D (mm)/ kg
	Low (+40°C)		High (+50°C)		Maximum current I <sub>s</sub>	230 V supply			
	Rated continuous current I <sub>L</sub> (A)	10% overload current (A)	Rated continuous current I <sub>H</sub> (A)	50% overload current (A)		10% overload P (kW)	50% overload P (kW)		
NXP 0003 2 A 2 H 1 SSS	3.7	4.1	2.4	3.6	4.8	0.55	0.37	FR4	128*292*190/ 5
NXP 0004 2 A 2 H 1 SSS	4.8	5.3	3.7	5.6	7.4	0.75	0.55	FR4	128*292*190/ 5
NXP 0007 2 A 2 H 1 SSS	6.6	7.3	4.8	7.2	9.6	1.1	0.75	FR4	128*292*190/ 5
NXP 0008 2 A 2 H 1 SSS	7.8	8.6	6.6	9.9	13.2	1.5	1.1	FR4	128*292*190/ 5
NXP 0011 2 A 2 H 1 SSS	11	12.1	7.8	11.7	15.6	2.2	1.5	FR4	128*292*190/ 5
NXP 0012 2 A 2 H 1 SSS	12.5	13.8	11	16.5	22	3	2.2	FR4	128*292*190/ 5
NXP 0017 2 A 2 H 1 SSS	17.5	19.3	12.5	18.8	25	4	3	FR5	144*391*214/ 8.1
NXP 0025 2 A 2 H 1 SSS	25	27.5	17.5	26.3	35	5.5	4	FR5	144*391*214/ 8.1
NXP 0031 2 A 2 H 1 SSS	31	34.1	25	37.5	50	7.5	5.5	FR5	144*391*214/ 8.1
NXP 0048 2 A 2 H 1 SSS	48	52.8	31	46.5	62	11	7.5	FR6	195*519*237/ 18.5
NXP 0061 2 A 2 H 1 SSS	61	67.1	48	72	96	15	11	FR6	195*519*237/ 18.5
NXP 0075 2 A 2 H 0 SSS	75	83	61	92	122	22	15	FR7	237*591*257/ 35
NXP 0088 2 A 2 H 0 SSS	88	97	75	113	150	22	22	FR7	237*591*257/ 35
NXP 0114 2 A 2 H 0 SSS	114	125	88	132	176	30	22	FR7	237*591*257/ 35
NXP 0140 2 A 2 H 0 SSS	140	154	105	158	210	37	30	FR8	291*758*344 / 58
NXP 0170 2 A 2 H 0 SSS	170	187	140	210	280	45	37	FR8	291*758*344 / 58
NXP 0205 2 A 2 H 0 SSS	205	226	170	255	336	55	45	FR8	291*758*344 / 58
NXP 0261 2 A 2 H 0 SSF	261	287	205	308	349	75	55	FR9	480*1150*362/ 146
NXP 0300 2 A 2 H 0 SSF	300	330	245	368	444	90	75	FR9	480*1150*362/ 146

### Mains voltage 380—500 V, 50/60 Hz, 3~

AC drive type	Loadability					Motor shaft power		Frame size	Dimensions and weight W*H*D (mm)/ kg
	Low (+40°C)		High (+50°C)		Maximum current I <sub>s</sub>	400 V supply			
	Rated continuous current I <sub>L</sub> (A)	10% overload current (A)	Rated continuous current I <sub>H</sub> (A)	50% overload current (A)		10% overload P (kW)	50% overload P (kW)		
NXP 0003 5 A 2 H 1 SSS	3.3	3.6	2.2	3.3	4.4	1.1	0.75	FR4	128*292*190/ 5
NXP 0004 5 A 2 H 1 SSS	4.3	4.7	3.3	5	6.2	1.5	1.1	FR4	128*292*190/ 5
NXP 0005 5 A 2 H 1 SSS	5.6	6.2	4.3	6.5	8.6	2.2	1.5	FR4	128*292*190/ 5
NXP 0007 5 A 2 H 1 SSS	7.6	8.4	5.6	8.4	10.8	3	2.2	FR4	128*292*190/ 5
NXP 0009 5 A 2 H 1 SSS	9	9.9	7.6	11.4	14	4	3	FR4	128*292*190/ 5
NXP 0012 5 A 2 H 1 SSS	12	13.2	9	13.5	18	5.5	4	FR4	128*292*190/ 5
NXP 0016 5 A 2 H 1 SSS	16	17.6	12	18	24	7.5	5.5	FR5	144*391*214/ 8.1
NXP 0022 5 A 2 H 1 SSS	23	25.3	16	24	32	11	7.5	FR5	144*391*214/ 8.1
NXP 0031 5 A 2 H 1 SSS	31	34	23	35	46	15	11	FR5	144*391*214/ 8.1
NXP 0038 5 A 2 H 1 SSS	38	42	31	47	62	18.5	15	FR6	195*519*237/ 18.5
NXP 0045 5 A 2 H 1 SSS	46	51	38	57	76	22	18.5	FR6	195*519*237/ 18.5
NXP 0061 5 A 2 H 1 SSS	61	67	46	69	92	30	22	FR6	195*519*237/ 18.5
NXP 0072 5 A 2 H 0 SSS	72	79	61	92	122	37	30	FR7	237*591*257/ 35
NXP 0087 5 A 2 H 0 SSS	87	96	72	108	144	45	37	FR7	237*591*257/ 35
NXP 0105 5 A 2 H 0 SSS	105	116	87	131	174	55	45	FR7	237*591*257/ 35
NXP 0140 5 A 2 H 0 SSS	140	154	105	158	210	75	55	FR8	291*758*344 / 58
NXP 0168 5 A 2 H 0 SSS	170	187	140	210	280	90	75	FR8	291*758*344 / 58
NXP 0205 5 A 2 H 0 SSS	205	226	170	255	336	110	90	FR8	291*758*344 / 58
NXP 0261 5 A 2 H 0 SSF	261	287	205	308	349	132	110	FR9	480*1150*362/ 146
NXP 0300 5 A 2 H 0 SSF	300	330	245	368	444	160	132	FR9	480*1150*362/ 146

# WALL-MOUNTED VACON NXP

Mains voltage 500—690 V, 50/60 Hz, 3~

AC drive type	Loadability					Motor shaft power			Frame size	Dimensions and weight W*H*D (mm)/ kg
	Low (+40°C)		High (+50°C)		Maximum current I <sub>S</sub>	690 V supply				
	Rated continuous current I <sub>L</sub> (A)	10% overload current (A)	Rated continuous current I <sub>H</sub> (A)	50% overload current (A)		10% overload P (kW)	50% overload P (kW)			
NXP 0004 6 A 2 L 0 SSS	4.5	5	3.2	4.8	6.4	3	2.2	FR6	195*519*237/ 18.5	
NXP 0005 6 A 2 L 0 SSS	5.5	6.1	4.5	6.8	9.0	4	3	FR6	195*519*237/ 18.5	
NXP 0007 6 A 2 L 0 SSS	7.5	8.3	5.5	8.3	11	5.5	4	FR6	195*519*237/ 18.5	
NXP 0010 6 A 2 L 0 SSS	10	11	7.5	11.3	15	7.5	5.5	FR6	195*519*237/ 18.5	
NXP 0013 6 A 2 L 0 SSS	13.5	14.9	10	15	20	11	7.5	FR6	195*519*237/ 18.5	
NXP 0018 6 A 2 L 0 SSS	18	19.8	13.5	20.3	27	15	11	FR6	195*519*237/ 18.5	
NXP 0022 6 A 2 L 0 SSS	22	24.2	18	27	36	18.5	15	FR6	195*519*237/ 18.5	
NXP 0027 6 A 2 L 0 SSS	27	29.7	22	33	44	22	18.5	FR6	195*519*237/ 18.5	
NXP 0034 6 A 2 L 0 SSS	34	37	27	41	54	30	22	FR6	195*519*237/ 18.5	
NXP 0041 6 A 2 L 0 SSS	41	45	34	51	68	37.5	30	FR7	237*591*257/ 35	
NXP 0052 6 A 2 L 0 SSS	52	57	41	62	82	45	37.5	FR7	237*591*257/ 35	
NXP 0062 6 A 2 L 0 SSS	62	68	52	78	104	55	45	FR8	291*758*344 / 58	
NXP 0080 6 A 2 L 0 SSS	80	88	62	93	124	75	55	FR8	291*758*344 / 58	
NXP 0100 6 A 2 L 0 SSS	100	110	80	120	160	90	75	FR8	291*758*344 / 58	
NXP 0125 6 A 2 L 0 SSF	125	138	100	150	200	110	90	FR9	480*1150*362/ 146	
NXP 0144 6 A 2 L 0 SSF	144	158	125	188	213	132	110	FR9	480*1150*362/ 146	
NXP 0170 6 A 2 L 0 SSF	170	187	144	216	245	160	132	FR9	480*1150*362/ 146	
NXP 0208 6 A 2 L 0 SSF	208	229	170	255	289	200	160	FR9	480*1150*362/ 146	



## STANDALONE VACON NXP

High-power Vacon NXP drives are also available in a compact standalone IP21 or IP54 enclosure. These units are designed for use in applications where the drive has to be compact and easy to install.

The Vacon NXP standalone drives are fully enclosed at the factory and are ready for immediate installation. The drive has integrated fuses as standard and no extra protections are required by the drive. It is also possible to equip the drive with an optional integrated load switch, which further simplifies handling in the field.

### Mains voltage 380—500 V, 50/60 Hz, 3-

AC drive type	Loadability					Motor shaft power			Frame size	Dimensions and weight W*H*D (mm)/ kg
	Low (+40°C)		High (+40°C)		Maximum current I <sub>S</sub>	400 V supply				
	Rated continuous current I <sub>L</sub> (A)	10% overload current (A)	Rated continuous current I <sub>H</sub> (A)	50% overload current (A)		10% overload P (kW)	50% overload P (kW)			
NXP 0385 5 A 2 L 0 SSA	385	424	300	450	540	200	160	FR10	595*2020*602/ 340	
NXP 0460 5 A 2 L 0 SSA	460	506	385	578	693	250	200	FR10	595*2020*602/ 340	
NXP 0520 5 A 2 L 0 SSA	520	572	460	690	828	250	250	FR10	595*2020*602/ 340	
NXP 0590 5 A 2 L 0 SSA	590	649	520	780	936	315	250	FR11	794*2020*602/ 470	
NXP 0650 5 A 2 L 0 SSA	650	715	590	885	1062	355	315	FR11	794*2020*602/ 470	
NXP 0730 5 A 2 L 0 SSA	730	803	650	975	1170	400	355	FR11	794*2020*602/ 470	

### Mains voltage 500—690 V, 50/60 Hz, 3-

AC drive type	Loadability					Motor shaft power			Frame size	Dimensions and weight W*H*D (mm)/ kg
	Low (+40°C)		High (+40°C)		Maximum current I <sub>S</sub>	690 V supply				
	Rated continuous current I <sub>L</sub> (A)	10% overload current (A)	Rated continuous current I <sub>H</sub> (A)	50% overload current (A)		10% overload P (kW)	50% overload P (kW)			
NXP 0261 6 A 2 L 0 SSA	261	287	208	312	375	250	200	FR10	595*2020*602/ 340	
NXP 0325 6 A 2 L 0 SSA	325	358	261	392	470	315	250	FR10	595*2020*602/ 340	
NXP 0385 6 A 2 L 0 SSA	385	424	325	488	585	355	315	FR10	595*2020*602/ 340	
NXP 0416 6 A 2 L 0 SSA <sup>#</sup>	416	458	325	488	585	400	315	FR10	595*2020*602/ 340	
NXP 0460 6 A 2 L 0 SSA	460	506	385	578	693	450	355	FR11	794*2020*602/ 400	
NXP 0502 6 A 2 L 0 SSA	502	552	460	690	828	500	450	FR11	794*2020*602/ 400	
NXP 0590 6 A 2 L 0 SSA <sup>#</sup>	590	649	502	753	904	560	500	FR11	794*2020*602/ 470	

<sup>#</sup> max. ambient temperature of +35°C

## HARDWARE CONFIGURATIONS

FUNCTION	AVAILABILITY
IP21	Standard
IP54 (FR10 only)	Optional
Integrated fuses	Standard
Load switch	Optional
EMC filtering L	Standard
EMC filtering T	Optional
Brake chopper (cabling top entry)	Optional (H: +122 mm)



## IPOO VACON NXP MODULES

The Vacon NXP high-power IP00 drive modules are intended for installation in a separate enclosure. Thanks to the robust, square-shaped design of the module, enclosure design is easy and straightforward.

### Mains voltage 380—500 V, 50/60 Hz, 3~

AC drive type	Loadability					Motor shaft power		Frame size	Module W*H*D (mm)/ kg	Chokes W*H*D (mm)/ kg
	Low (+40°C)		High (+40°C)		Maximum current I <sub>S</sub>	400 V supply				
	Rated continuous current I <sub>L</sub> (A)	10% overload current (A)	Rated continuous current I <sub>H</sub> (A)	50% overload current (A)		10% overload P (kW)	50% overload P (kW)			
NXP 0385 5 A 0 N 0 SSA	385	424	300	450	540	200	160	FR10	500*1165*506/ 120	350*383*262/ 84 <sup>1)</sup>
NXP 0460 5 A 0 N 0 SSA	460	506	385	578	693	250	200	FR10	500*1165*506/ 120	497*399*244/ 115 <sup>1)</sup>
NXP 0520 5 A 0 N 0 SSA	520	572	460	690	828	250	250	FR10	500*1165*506/ 120	497*399*244/ 115 <sup>1)</sup>
NXP 0590 5 A 0 N 0 SSA	590	649	520	780	936	315	250	FR11	709*1206*506/ 210	2x(350*383*262/84)
NXP 0650 5 A 0 N 0 SSA	650	715	590	885	1062	355	315	FR11	709*1206*506/ 210	2x(350*383*262/84)
NXP 0730 5 A 0 N 0 SSA	730	803	650	975	1170	400	355	FR11	709*1206*506/ 210	2x(350*383*262/84)
NXP 0820 5 A 0 N 0 SSA	820	902	730	1095	1314	450	400	FR12	2x(500*1165*506/120)	2x(497*399*244/115)
NXP 0920 5 A 0 N 0 SSA	920	1012	820	1230	1476	500	450	FR12	2x(500*1165*506/120)	2x(497*399*244/115)
NXP 1030 5 A 0 N 0 SSA	1030	1133	920	1380	1656	560	500	FR12	2x(500*1165*506/120)	2x(497*399*244/115)

1) 12-pulse units, 2x(354\*319\*230/ 53 kg)

### Mains voltage 500—690 V, 50/60 Hz, 3~

AC drive type	Loadability					Motor shaft power		Frame size	Module W*H*D (mm)/ kg	Chokes W*H*D (mm)/ kg
	Low (+40°C)		High (+40°C)		Maximum current I <sub>S</sub>	690 V supply				
	Rated continuous current I <sub>L</sub> (A)	10% overload current (A)	Rated continuous current I <sub>H</sub> (A)	50% overload current (A)		10% overload P (kW)	50% overload P (kW)			
NXP 0261 6 A 0 N 0 SSA	261	287	208	312	375	250	200	FR10	500*1165*506/ 120	354*319*230/ 53 <sup>1)</sup>
NXP 0325 6 A 0 N 0 SSA	325	358	261	392	470	315	250	FR10	500*1165*506/ 120	350*383*262/ 84 <sup>1)</sup>
NXP 0385 6 A 0 N 0 SSA	385	424	325	488	585	355	315	FR10	500*1165*506/ 120	350*383*262/ 84 <sup>1)</sup>
NXP 0416 6 A 0 N 0 SSA <sup>#</sup>	416	458	325	488	585	400	315	FR10	500*1165*506/ 120	350*383*262/ 84 <sup>1)</sup>
NXP 0460 6 A 0 N 0 SSA	460	506	385	578	693	450	355	FR11	709*1206*506/ 210	497*399*244/ 115 <sup>2)</sup>
NXP 0502 6 A 0 N 0 SSA	502	552	460	690	828	500	450	FR11	709*1206*506/ 210	497*399*244/ 115 <sup>2)</sup>
NXP 0590 6 A 0 N 0 SSA <sup>#</sup>	590	649	502	753	904	560	500	FR11	709*1206*506/ 210	2x(350*383*262/84)
NXP 0650 6 A 0 N 0 SSA	650	715	590	885	1062	630	560	FR12	2x(500*1165*506/120)	2x(350*383*262/84)
NXP 0750 6 A 0 N 0 SSA	750	825	650	975	1170	710	630	FR12	2x(500*1165*506/120)	2x(350*383*262/84)
NXP 0820 6 A 0 N 0 SSA <sup>#</sup>	820	902	650	975	1170	800	630	FR12	2x(500*1165*506/120)	2x(350*383*262/84)

<sup>#</sup> max. ambient temperature of +35°C

1) 12-pulse units, 2x(354\*319\*230/ 53 kg)

2) 12-pulse units, 2x(350\*383\*262/ 84 kg)

Bigger units are available on request.

## HARDWARE CONFIGURATIONS

FUNCTION	AVAILABILITY
Integrated control unit	Standard
External control unit	Optional
Integrated brake chopper	Optional
6-pulse supply	Standard
12-pulse supply	Optional
EMC filtering N	Standard
EMC filtering T	Optional

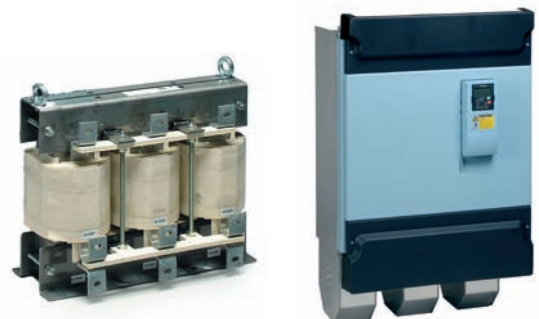

## VACON NXC, COMPACT AND FLEXIBLE

The Vacon NXC cabinet drive is compact and well tested, fully utilizing the flexibility of the Vacon NXP drive. The Vacon NXC is designed to meet the most demanding requirements for flexibility, robustness, compactness and service-friendliness. It is a safe choice for any application.

### Easy ordering

The Vacon NXC contains the AC drive itself and optional items such as main switch, contactor, control options and output filtering in one compact unit which is easy to install and service. Ordering is made easy by integrating the Vacon NXC enclosure options into the typecode, to which they are appended with "+" codes.

### User-friendly

In the Vacon NXC, the control unit is mounted in a separate compartment at an easily accessible height together with all control options. Ample space around the power terminals allows easy installation and connection of power cables. Bottom plates and earthing clamps for 360-degree earthing of motor cable shields are provided as standard.

### Well tested

Vacon NXC drives are the result of more than 20 years of experience in enclosure design. It is a well tested and proven solution. The good thermal handling of the enclosure guarantees a long lifetime for the AC drive and trouble-free operation even in the most demanding environments. Approved EMC solutions ensure reliable operation of the converter without disturbing other electrical equipment.

### Service-friendly

The Vacon NXC enclosures are designed to fully utilize the new and innovative installation features of the high-power Vacon NXP. The Vacon NXP power units are mounted on rails which are extendable with a pull-out jig. The jig can be used for pulling the power unit out of the enclosure for service.





# VACON NXP/NXC TYPE DESIGNATION CODE

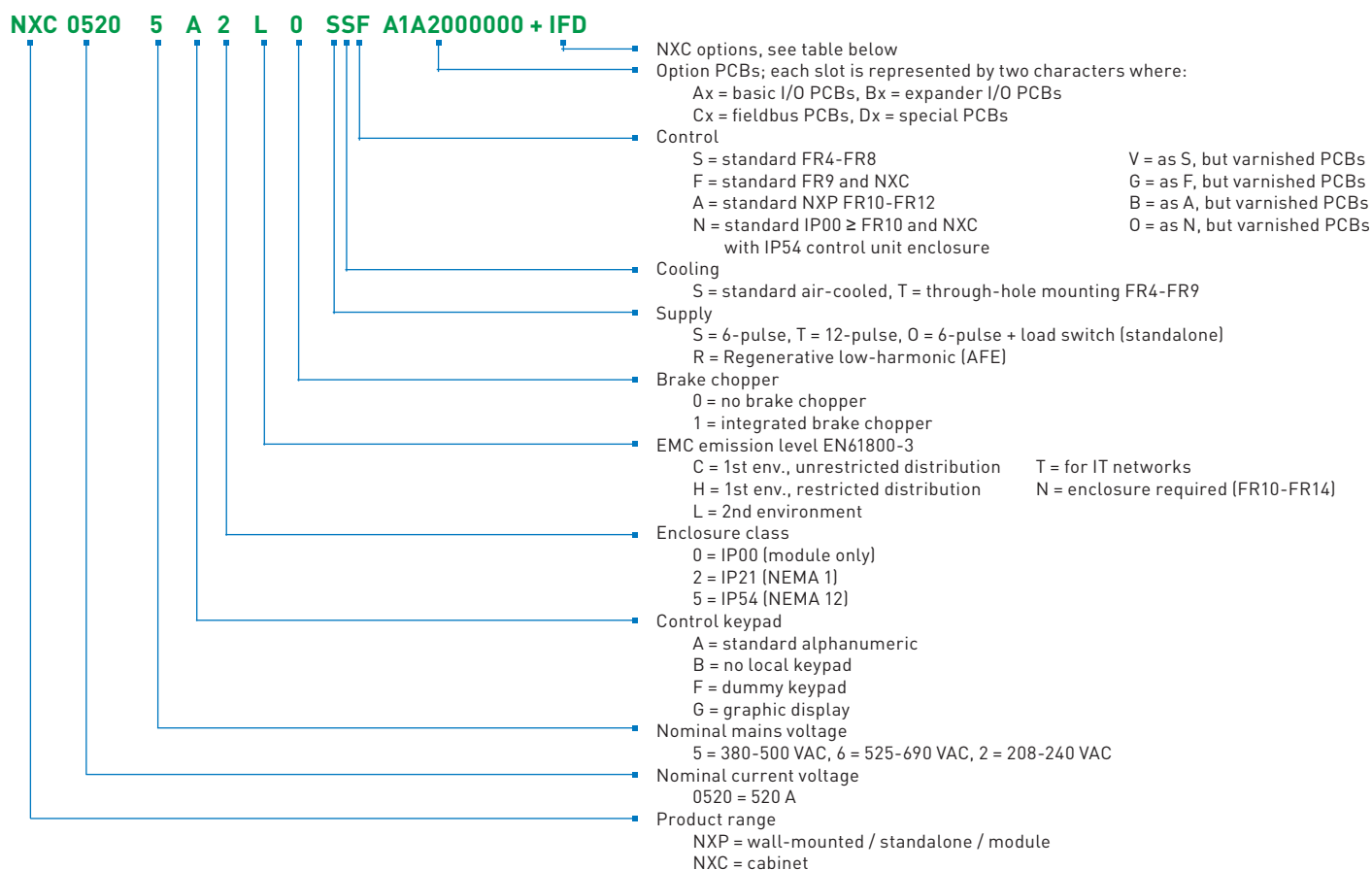

## VACON NXC OPTIONS

Control terminal options (T group)	
+TIO	Basic I/O wired to external terminals
+TID	Basic I/O wired to external terminals + additional terminals
+TUP	Terminals for 230 VAC control voltage
Input device options (I group)	
+ILS	Load switch
+IFD	Switch fuse and fuses
+ICB	Circuit breaker (MCCB)
+ICO	Input contactor
+IFU	Input fuses
Main circuit options (M group)	
+MDC	Terminals in cabinet for DC / brake chopper
Output filter options (O group)	
+OCM	Common mode filters
+ODU	du/dt filter
+OSI	Sine wave filter
Protection devices (P group)	
+PTR	External thermistor relay
+PES	Emergency stop (cat 0)
+PED	Emergency stop (cat 1)
+PAP	Arc protection
+PIF	Insulation fault sensor
General options (G group)	
+G40	400 mm empty cabinet
+G60	600 mm empty cabinet
+G80	800 mm empty cabinet
+GPL	100 mm base
Cabling options (C group)	
+CIT	Input (mains) cabling from top
+COT	Output (motor) cabling from top

Auxiliary equipment (A group)	
+AMF	Motor fan control
+AMH	Motor heater feeder
+AMB	Mechanical brake control
+AMO	Motor operator for +ICB
+ACH	Cabinet heater
+ACL	Cabinet light
+ACR	Control relay
+AAI	Analog signal isolator
+AAA	Auxiliary contact (control voltage devices)
+AAC	Auxiliary contact (input device)
+AT1	Auxiliary voltage transformer 200 VA
+AT2	Auxiliary voltage transformer 750 VA
+AT3	Auxiliary voltage transformer 2500 VA
+AT4	Auxiliary voltage transformer 4000 VA
+ADC	Power supply 24 VDC 2.5 A
+ACS	230 VAC customer socket
Door-mounted options (D group)	
+DLV	Pilot light (Control voltage on)
+DLD	Pilot light (DO1)
+DLF	Pilot light (FLT)
+DLR	Pilot light (RUN)
+DCO	Main contactor operation switch
+DRO	Local / Remote operation switch
+DEP	Emergency stop push-button
+DRP	Reset push-button
+DAM	Analog meter (A01)
+DAR	Potentiometer for reference
+DCM	Analog meter + current trafo
+DVM	Analog voltage meter with selection switch

# VACON NXC, 6-PULSE SUPPLY

## Mains voltage 380—500 V, 50/60 Hz

AC drive type	Loadability					Motor shaft power			Frame size	Dimensions and weight W*H*D (mm)/ kg
	Low (+40°C)		High (+40°C)		Maximum current I <sub>S</sub>	400 V supply				
	Rated continuous current I <sub>L</sub> (A)	10% overload current (A)	Rated continuous current I <sub>H</sub> (A)	50% overload current (A)		10% overload P (kW)	50% overload P (kW)			
NXC 0261 5 A 2 H 0 SSF	261	287	205	308	349	132	110	FR9	606*2275*605/ 371	
NXC 0300 5 A 2 H 0 SSF	300	330	245	368	444	160	132	FR9	606*2275*605/ 371	
NXC 0385 5 A 2 L 0 SSF	385	424	300	450	540	200	160	FR10	606*2275*605/ 371	
NXC 0460 5 A 2 L 0 SSF	460	506	385	578	693	250	200	FR10	606*2275*605/ 403	
NXC 0520 5 A 2 L 0 SSF	520	572	460	690	828	250	250	FR10	606*2275*605/ 403	
NXC 0590 5 A 2 L 0 SSF	590	649	520	780	936	315	250	FR11	806*2275*605/ 577	
NXC 0650 5 A 2 L 0 SSF	650	715	590	885	1062	355	315	FR11	806*2275*605/ 577	
NXC 0730 5 A 2 L 0 SSF	730	803	650	975	1170	400	355	FR11	806*2275*605/ 577	
NXC 0820 5 A 2 L 0 SSF	820	902	730	1095	1314	450	400	FR12	1206*2275*605/ 810	
NXC 0920 5 A 2 L 0 SSF	920	1012	820	1230	1476	500	450	FR12	1206*2275*605/ 810	
NXC 1030 5 A 2 L 0 SSF	1030	1133	920	1380	1656	560	500	FR12	1206*2275*605/ 810	
NXC 1150 5 A 2 L 0 SSF	1150	1265	1030	1545	1854	630	560	FR13	1406*2275*605/ 1000	
NXC 1300 5 A 2 L 0 SSF	1300	1430	1150	1725	2070	710	630	FR13	1406*2275*605/ 1100	
NXC 1450 5 A 2 L 0 SSF	1450	1595	1300	1950	2340	800	710	FR13	1606*2275*605/ 1100	
NXC 1770 5 A 2 L 0 SSF	1770	1947	1600	2400	2880	1000	900	FR14	2806*2275*605/ 2440	
NXC 2150 5 A 2 L 0 SSF	2150	2365	1940	2910	3492	1200	1100	FR14	2806*2275*605/ 2500	

## Mains voltage 500—690 V, 50/60 Hz

AC drive type	Loadability					Motor shaft power			Frame size	Dimensions and weight W*H*D (mm)/ kg
	Low (+40°C)		High (+40°C)		Maximum current I <sub>S</sub>	690 V supply				
	Rated continuous current I <sub>L</sub> (A)	10% overload current (A)	Rated continuous current I <sub>H</sub> (A)	50% overload current (A)		10% overload P (kW)	50% overload P (kW)			
NXC 0125 6 A 2 L 0 SSF	125	138	100	150	200	110	90	FR9	606*2275*605/ 371	
NXC 0144 6 A 2 L 0 SSF	144	158	125	188	213	132	110	FR9	606*2275*605/ 371	
NXC 0170 6 A 2 L 0 SSF	170	187	144	216	245	160	132	FR9	606*2275*605/ 371	
NXC 0208 6 A 2 L 0 SSF	208	229	170	255	289	200	160	FR9	606*2275*605/ 371	
NXC 0261 6 A 2 L 0 SSF	261	287	208	312	375	250	200	FR10	606*2275*605/ 341	
NXC 0325 6 A 2 L 0 SSF	325	358	261	392	470	315	250	FR10	606*2275*605/ 371	
NXC 0385 6 A 2 L 0 SSF	385	424	325	488	585	355	315	FR10	606*2275*605/ 371	
NXC 0416 6 A 2 L 0 SSF#	416	458	325	488	585	400	315	FR10	606*2275*605/ 371	
NXC 0460 6 A 2 L 0 SSF	460	506	385	578	693	450	355	FR11	806*2275*605/ 524	
NXC 0502 6 A 2 L 0 SSF	502	552	460	690	828	500	450	FR11	806*2275*605/ 524	
NXC 0590 6 A 2 L 0 SSF#	590	649	502	753	904	560	500	FR11	806*2275*605/ 577	
NXC 0650 6 A 2 L 0 SSF	650	715	590	885	1062	630	560	FR12	1206*2275*605/ 745	
NXC 0750 6 A 2 L 0 SSF	750	825	650	975	1170	710	630	FR12	1206*2275*605/ 745	
NXC 0820 6 A 2 L 0 SSF#	820	902	650	975	1170	800	630	FR12	1206*2275*605/ 745	
NXC 0920 6 A 2 L 0 SSF	920	1012	820	1230	1410	900	800	FR13	1406*2275*605/ 1000	
NXC 1030 6 A 2 L 0 SSF	1030	1133	920	1380	1755	1000	900	FR13	1406*2275*605/ 1000	
NXC 1180 6 A 2 L 0 SSF#	1180	1298	1030	1463	1755	1150	1000	FR13	1406*2275*605/ 1000	
NXC 1500 6 A 2 L 0 SSF	1500	1650	1300	1950	2340	1500	1300	FR14	2406*2275*605/ 2350	
NXC 1900 6 A 2 L 0 SSF	1900	2090	1500	2250	2700	1800	1500	FR14	2806*2275*605/ 2440	
NXC 2250 6 A 2 L 0 SSF#	2250	2475	1900	2782	3335	2000	1800	FR14	2806*2275*605/ 2500	

# max. ambient temperature of +35°C

## HARDWARE CONFIGURATIONS

6-pulse	Enclosure		EMC			Brake chopper	Cabling		Input device					Output filters		
	380-500 V	IP21	IP54	L	T		H	Bottom	Top	Fuses	Load Sw.	Sw.-fuse	Contactor	MCCB	Cmn Mode	du/dt
FR9	S	O (H: +130)	S	O	-	0	S	O (W: +400)	0	0	0	0	0	0	O (W: +400)	O (W: +600)
FR10	S	O (H: +130)	S	O	-	0	S	O (W: +400)	0	0	0	0	0	0	O (W: +400)	O (W: +600)
FR11	S	O (H: +130)*	S	O	-	0	S	O (W: +400)	0	0	0	0	0	0	O (W: +400)	O (W: +600-800)
FR12	S	O (H: +130)	S	O	-	0	S	O (W: +400)	0	0	0	0	0	0	O (W: +400)	O (W: +1200)
FR13	S	O (H: +170)	S	O	-	1	S	O (W: +400)	-	-	S	-	0	0	0	O (W: +800)
FR14	S	O (H: +170)	S	O	-	1	S	O (W: +600)	-	-	-	-	S	0	S	O (W: +1600)
<b>500-690 V</b>																
FR9	S	O (H: +130)	S	O	-	0	S	O (W: +400)	0	0	0	0	0	0	O (W: +400)	O (W: +600)
FR10	S	O (H: +130)	S	O	-	0	S	O (W: +400)	0	0	0	0	0	0	O (W: +400)	O (W: +600)
FR11	S	O (H: +130)*	S	O	-	0	S	O (W: +400)	0	0	0	0	0	0	O (W: +400)	O (W: +600)
FR12	S	O (H: +130)	S	O	-	0	S	O (W: +400)	0	0	0	0	0	0	O (W: +400)	O (W: +1200)
FR13	S	O (H: +170)	S	O	-	1	S	O (W: +400)	-	-	S	-	0	0	0	O (W: +800)
FR14	S	O (H: +170)	S	O	-	1	S	O (W: +600)	-	-	-	-	S	0	S	O (W: +1600)

S = Standard    O = Optional    <sup>1)</sup> (W: +400) = Contact factory    \*) NXC07305 and NXC05906, H: +170 mm

# VACON NXC, 12-PULSE SUPPLY

## Mains voltage 380—500 V, 50/60 Hz

AC drive type	Loadability					Motor shaft power		Frame size	Dimensions and weight W*H*D (mm)/ kg
	Low (+40°C)		High (+40°C)		Maximum current I <sub>s</sub>	400 V supply			
	Rated continuous current I <sub>L</sub> (A)	10% overload current (A)	Rated continuous current I <sub>H</sub> (A)	50% overload current (A)		10% overload P (kW)	50% overload P (kW)		
NXC 0385 5 A 2 L 0 TSF	385	424	300	450	540	200	160	FR10	606*2275*605/ 371
NXC 0460 5 A 2 L 0 TSF	460	506	385	578	693	250	200	FR10	606*2275*605/ 403
NXC 0520 5 A 2 L 0 TSF	520	572	460	690	828	250	250	FR10	606*2275*605/ 403
NXC 0590 5 A 2 L 0 TSF	590	649	520	780	936	315	250	FR11	806*2275*605/ 577
NXC 0650 5 A 2 L 0 TSF	650	715	590	885	1062	355	315	FR11	806*2275*605/ 577
NXC 0730 5 A 2 L 0 TSF	730	803	650	975	1170	400	355	FR11	806*2275*605/ 577
NXC 0820 5 A 2 L 0 TSF	820	902	730	1095	1314	450	400	FR12	1206*2275*605/ 810
NXC 0920 5 A 2 L 0 TSF	920	1012	820	1230	1476	500	450	FR12	1206*2275*605/ 810
NXC 1030 5 A 2 L 0 TSF	1030	1133	920	1380	1656	560	500	FR12	1206*2275*605/ 810
NXC 1150 5 A 2 L 0 TSF	1150	1265	1030	1545	1854	630	560	FR13	1406*2275*605/ 1000
NXC 1300 5 A 2 L 0 TSF	1300	1430	1150	1725	2070	710	630	FR13	2006*2275*605/ 1100
NXC 1450 5 A 2 L 0 TSF	1450	1595	1300	1950	2340	800	710	FR13	2006*2275*605/ 1100
NXC 1770 5 A 2 L 0 TSF	1770	1947	1600	2400	2880	1000	900	FR14	2806*2275*605/ 2440
NXC 2150 5 A 2 L 0 TSF	2150	2365	1940	2910	3492	1200	1100	FR14	2806*2275*605/ 2500

## Mains voltage 500—690 V, 50/60 Hz

AC drive type	Loadability					Motor shaft power		Frame size	Dimensions and weight W*H*D (mm)/ kg
	Low (+40°C)		High (+40°C)		Maximum current I <sub>s</sub>	690 V supply			
	Rated continuous current I <sub>L</sub> (A)	10% overload current (A)	Rated continuous current I <sub>H</sub> (A)	50% overload current (A)		10% overload P (kW)	50% overload P (kW)		
NXC 0261 6 A 2 L 0 TSF	261	287	208	312	375	250	200	FR10	606*2275*605/ 341
NXC 0325 6 A 2 L 0 TSF	325	358	261	392	470	315	250	FR10	606*2275*605/ 371
NXC 0385 6 A 2 L 0 TSF	385	424	325	488	585	355	315	FR10	606*2275*605/ 371
NXC 0416 6 A 2 L 0 TSF <sup>#</sup>	416	458	325	488	585	400	315	FR10	606*2275*605/ 403
NXC 0460 6 A 2 L 0 TSF	460	506	385	578	693	450	355	FR11	806*2275*605/ 524
NXC 0502 6 A 2 L 0 TSF	502	552	460	690	828	500	450	FR11	806*2275*605/ 524
NXC 0590 6 A 2 L 0 TSF <sup>#</sup>	590	649	502	753	904	560	500	FR11	806*2275*605/ 577
NXC 0650 6 A 2 L 0 TSF	650	715	590	885	1062	630	560	FR12	1206*2275*605/ 745
NXC 0750 6 A 2 L 0 TSF	750	825	650	975	1170	710	630	FR12	1206*2275*605/ 745
NXC 0820 6 A 2 L 0 TSF <sup>#</sup>	820	902	650	975	1170	800	630	FR12	1206*2275*605/ 745
NXC 0920 6 A 2 L 0 TSF	920	1012	820	1230	1410	900	800	FR13	1406*2275*605/ 1000
NXC 1030 6 A 2 L 0 TSF	1030	1133	920	1380	1755	1000	900	FR13	1406*2275*605/ 1000
NXC 1180 6 A 2 L 0 TSF <sup>#</sup>	1180	1298	1030	1463	1755	1150	1000	FR13	1406*2275*605/ 1000
NXC 1500 6 A 2 L 0 TSF	1500	1650	1300	1950	2340	1500	1300	FR14	2806*2275*605/ 2440
NXC 1900 6 A 2 L 0 TSF	1900	2090	1500	2250	2700	1800	1500	FR14	2806*2275*605/ 2440
NXC 2250 6 A 2 L 0 TSF <sup>#</sup>	2250	2475	1900	2782	3335	2000	1800	FR14	2806*2275*605/ 2500

<sup>#</sup> max. ambient temperature of +35°C

## HARDWARE CONFIGURATIONS

12-pulse	Enclosure		EMC			Brake chopper	Cabling		Input device					Output filters		
	IP21	IP54	L	T	H		Top	Bottom	+CIT/+COT	Fuses	Load Sw.	Sw.-fuse	Contactor	MCCB	Cmn Mode	du/dt
380-500 V									+IFU	+ILS	+IFD	+ICO	+ICB	+OCM	+ODU	+OSI
FR10	S	O (H: +130)	S	O	-	-	S	O (W: +400)	0	-	-	-	0	0	O (W: +400)	O (W: +600)
FR11	S	O (H: +130)*	S	O	-	0	S	O (W: +400)	0	0	0	0	0	0	O (W: +400)	O (W: +600-800)
FR12	S	O (H: +130)	S	O	-	0	S	O (W: +400)	0	0	0	0	0	0	O (W: +400)	O (W: +1200)
FR13	S	O (H: +170)	S	O	-	1	S	O (W: +400)	-	-	-	-	S	0	0	O (W: +800)
FR14	S	O (H: +170)	S	O	-	1	S	O (W: +800)	-	-	-	-	S	0	S	O (W: +1600)
<b>500-690 V</b>																
FR10	S	O (H: +130)	S	O	-	-	S	O (W: +400)	0	-	-	-	0	0	O (W: +400)	O (W: +600)
FR11	S	O (H: +130)*	S	O	-	0	S	O (W: +400)	0	0	0	0	0	0	O (W: +400)	O (W: +600)
FR12	S	O (H: +130)	S	O	-	0	S	O (W: +400)	0	0	0	0	0	0	O (W: +400)	O (W: +1200)
FR13	S	O (H: +170)	S	O	-	1	S	O (W: +400)	-	-	-	-	S	0	0	O (W: +800)
FR14	S	O (H: +170)	S	O	-	1	S	O (W: +800)	-	-	-	-	S	0	S	O (W: +1600)

S = Standard

O = Optional

<sup>1)</sup> (W: +400) = Contact factory

\*) NXC07305 and NXC05906, H: +170 mm

## VACON NXC, REGENERATIVE LOW-HARMONIC DRIVE

The Vacon NXC regenerative low-harmonic brings savings in applications in which either regenerative function or low-harmonics are required.

The Vacon NXC regenerative and low-harmonic cabinet drives are a perfect choice for applications where low harmonics are required or where energy is fed back to the mains.

### Clean power saves costs

The regenerative low-harmonic cabinet drive offers an excellent total solution to meet even the most demanding power quality requirements. The drive complies with the IEEE-519, G5/4 harmonic standards, when correctly installed. The low current THDi reduces supply currents and allows supply transformers, protection devices and power cables to be smaller. It brings savings for new and retrofit projects because there is no need to invest in expensive 12- or 18-pulse transformers when new or old existing 6-pulse transformers can be used.

### Regenerative functionality saves energy

The regenerative function makes it possible to feed energy back to the mains in energy generation applications or to improve the efficiency of the system when the braking power can be fed back to the mains. An additional advantage is simplified installation work and space savings when no brake resistors are needed.

### Power factor control improves the supply

The power factor of the active supply unit can be set in a wide range that makes it possible to minimize the required reactive power of the system.

### Main features

- Clean power with total current harmonics less than 5%
- Regenerative function brings savings
- Power factor control
- Compact solution with a wide range of standard options available makes it easy to configure the drive



## VACON NXC OPTIONS

Vacon NXC options give greater flexibility and make it easy to extend the range of functions. Options are available in different categories and can be combined to meet almost any requirements.

<p><b>Auxiliary equipment (A group)</b></p> <ul style="list-style-type: none"> <li>+AMF Motor fan control</li> <li>+AMH Motor heater feeder</li> <li>+AMB Mechanical brake control</li> <li>+ACH Cabinet heater</li> <li>+ACL Cabinet light</li> <li>+ACR Control relay</li> <li>+AAI Analog signal isolator</li> <li>+AAA Aux. contact (ctrl voltage)</li> <li>+AAC Aux. contact (input device)</li> <li>+AT3 Aux. voltage transformer 2500 VA</li> <li>+AT4 Aux. voltage transformer 4000 VA</li> <li>+ADS 230 VAC customer socket</li> </ul> <p><b>Control terminal options (T group)</b></p> <ul style="list-style-type: none"> <li>+TIO Basic I/O wired to external terminals</li> <li>+TID Basic I/O wired to external terminals + additional terminals</li> </ul>	<p><b>Door-mounted options (D group)</b></p> <ul style="list-style-type: none"> <li>+DLV Pilot light (control voltage on)</li> <li>+DLD Pilot light (DO1)</li> <li>+DLF Pilot light (FLT)</li> <li>+DLR Pilot light (RUN)</li> <li>+DEP Emergency stop push-button</li> <li>+DRP Reset push-button</li> <li>+DAM Analog meter (AO1)</li> <li>+DAR Potentiometer for reference</li> <li>+DCM Analog meter current trafo</li> <li>+DVM Analog voltage meter switch</li> </ul> <p><b>General options (G group)</b></p> <ul style="list-style-type: none"> <li>+G40 400 mm empty cabinet</li> <li>+G60 600 mm empty cabinet</li> <li>+G80 800 mm empty cabinet</li> <li>+GPL 100 mm base</li> </ul>	<p><b>Output filter options (O group)</b></p> <ul style="list-style-type: none"> <li>+OCM Common mode filters</li> <li>+ODU du/dt filter</li> <li>+OSI Sine wave filter</li> </ul> <p><b>Protection devices (P group)</b></p> <ul style="list-style-type: none"> <li>+PTR External thermistor relay</li> <li>+PES Emergency stop (cat 0)</li> <li>+PED Emergency stop (cat 1)</li> <li>+PAP Arc protection</li> <li>+PIF Insulation fault sensor</li> </ul> <p><b>Cabling options (C group)</b></p> <ul style="list-style-type: none"> <li>+CIT Input (mains) cabling from top</li> <li>+COT Output (motor) cabling from top</li> </ul>
--	---	---

## CURRENT HARMONIC MITIGATION

**6-pulse rectifier with choke**

Cost-effective transformer and simple power cabling with high current distortion. Oversizing of transformers needed due to high THDi.

Direction of power →

Current distortion (THDi) > 35 %

**12-pulse rectifier with choke**

Higher transformer and power cabling cost. Low current distortion on primary side of transformer.

Direction of power →

Current distortion (THDi) > 12 %

**Active front-end with LCL filter**

Cost effective transformer and power cabling with very low current distortion. No oversizing of transformer needed.

Direction of power ↔

Current distortion (THDi) < 5 %

# VACON NXC, REGENERATIVE LOW-HARMONIC DRIVE

## Mains voltage 380–500 V, 50/60 Hz, 3~

Low-harmonic regenerative drive type	Loadability					Motor shaft power		Frame size	Dimensions and weight W*H*D (mm)/ kg
	Low (+40°C)		High (+40°C)		Maximum current I <sub>s</sub> (A)	400 V supply			
	Rated continuous current I <sub>L</sub> (A)	10% overload current (A)	Rated continuous current I <sub>H</sub> (A)	50% overload current (A)		10% overload P (kW)	50% overload P (kW)		
NXC 0261 5 A 2 L 0 RSF	261	287	205	308	349	132	110	F19 + F19	1006x2275x605/680
NXC 0300 5 A 2 L 0 RSF	300	330	245	368	444	160	132	F19 + F19	1006x2275x605/680
NXC 0385 5 A 2 L 0 RSF	385	424	300	450	540	200	160	F110 + F110	1006x2275x605/700
NXC 0460 5 A 2 L 0 RSF	460	506	385	578	693	250	200	F110 + F110	1006x2275x605/700
NXC 0520 5 A 2 L 0 RSF	520	572	460	690	828	250	250	F110 + F110	1006x2275x605/700
NXC 0650 5 A 2 L 0 RSF	650	715	590	885	1062	355	315	2x F110 + F112	2006x2275x605/1400
NXC 0730 5 A 2 L 0 RSF	730	803	650	975	1170	400	355	2x F110 + F112	2006x2275x605/1400
NXC 0820 5 A 2 L 0 RSF	820	902	730	1095	1314	450	400	2x F110 + F112	2006x2275x605/1400
NXC 0920 5 A 2 L 0 RSF	920	1012	820	1230	1476	500	450	2x F110 + F112	2006x2275x605/1400
NXC 1030 5 A 2 L 0 RSF	1030	1133	920	1380	1656	560	500	2x F110 + F112	2006x2275x605/1400
NXC 1150 5 A 2 L 0 RSF	1150	1265	1030	1545	1854	630	560	F113 + F113	2206x2275x605/1950
NXC 1300 5 A 2 L 0 RSF	1300	1430	1150	1725	2070	710	630	F113 + F113	2206x2275x605/1950
NXC 1450 5 A 2 L 0 RSF	1450	1595	1300	1950	2340	800	710	F113 + F113	2206x2275x605/1950
NXC 1770 5 A 2 L 0 RSF	1770	1947	1600	2400	2880	1000	900	2x F113 + F114	4406x2275x605/3900
NXC 2150 5 A 2 L 0 RSF	2150	2365	1940	2910	3492	1200	1100	2x F113 + F114	4406x2275x605/3900
NXC 2700 5 A 2 L 0 RSF	2700	2970	2300	3278	3933	1500	1200	2x F113 + F114	4406x2275x605/3900

## Mains voltage 525–690 V, 50/60 Hz, 3~

Low-harmonic regenerative drive type	Loadability					Motor shaft power		Frame size	Dimensions and weight W*H*D (mm)/ kg
	Low (+40°C)		High (+40°C)		Maximum current I <sub>s</sub> (A)	690 V supply			
	Rated continuous current I <sub>L</sub> (A)	10% overload current (A)	Rated continuous current I <sub>H</sub> (A)	50% overload current (A)		10% overload P (kW)	50% overload P (kW)		
NXC 0125 6 A 2 L 0 RSF	125	138	100	150	200	110	90	F19 + F19	1006x2275x605/680
NXC 0144 6 A 2 L 0 RSF	144	158	125	188	213	132	110	F19 + F19	1006x2275x605/680
NXC 0170 6 A 2 L 0 RSF	170	187	144	216	245	160	132	F19 + F19	1006x2275x605/680
NXC 0208 6 A 2 L 0 RSF#	208	229	170	255	289	200	160	F19 + F19	1006x2275x605/680
NXC 0261 6 A 2 L 0 RSF	261	287	208	312	375	250	200	F110 + F110	1006x2275x605/700
NXC 0325 6 A 2 L 0 RSF	325	358	261	392	470	315	250	F110 + F110	1006x2275x605/700
NXC 0385 6 A 2 L 0 RSF	385	424	325	488	585	355	315	F110 + F110	1006x2275x605/700
NXC 0416 6 A 2 L 0 RSF#	416	416	325	488	585	400	315	F110 + F110	1006x2275x605/700
NXC 0460 6 A 2 L 0 RSF	460	506	385	578	693	450	355	2x F110 + F112	2006x2275x605/1400
NXC 0502 6 A 2 L 0 RSF	502	552	460	690	828	500	450	2x F110 + F112	2006x2275x605/1400
NXC 0590 6 A 2 L 0 RSF	590	649	502	753	904	560	500	2x F110 + F112	2006x2275x605/1400
NXC 0650 6 A 2 L 0 RSF	650	715	590	885	1062	630	560	2x F110 + F112	2006x2275x605/1400
NXC 0750 6 A 2 L 0 RSF	750	825	650	975	1170	710	630	2x F110 + F112	2006x2275x605/1400
NXC 0820 6 A 2 L 0 RSF#	820	902	650	975	1170	800	630	2x F110 + F112	2006x2275x605/1400
NXC 0920 6 A 2 L 0 RSF	920	1012	820	1230	1476	900	800	F113 + F113	2206x2275x605/1950
NXC 1030 6 A 2 L 0 RSF	1030	1133	920	1380	1656	1000	900	F113 + F113	2206x2275x605/1950
NXC 1180 6 A 2 L 0 RSF#	1180	1298	1030	1463	1755	1150	1000	F113 + F113	2206x2275x605/1950
NXC 1500 6 A 2 L 0 RSF	1500	1650	1300	1950	2340	1500	1300	2x F113 + F114	4406x2275x605/3900
NXC 1900 6 A 2 L 0 RSF	1900	2090	1500	2250	2700	1800	1500	2x F113 + F114	4406x2275x605/3900
NXC 2250 6 A 2 L 0 RSF#	2250	2475	1900	2782	3335	2000	1800	2x F113 + F114	4406x2275x605/3900

# max. ambient temperature of 35°C

## HARDWARE CONFIGURATIONS

Active supply unit	Enclosure		EMC		Brake chopper	Cabling		Input device Load Sw. & MCCB +ILS & +ICB	Output filters		
	380-500 V	IP21	IP54	L		T	Bottom		Top +CIT/+COT	Cmn Mode +OCM	du/dt +ODU
F19+F19	S	0 (H: +130)	S	0	1) (W: +400)	S	0 (W: +400)	S	0	0 (W: +400)	0 (W: +600)
F110+F110	S	0 (H: +130)	S	0	1) (W: +400)	S	0 (W: +400)	S	0	0 (W: +400)	0 (W: +600)
2 x F110+F112	S	0 (H: +130)	S	0	1) (W: +400)	S	0 (W: +400)	S	0	0 (W: +400)	0 (W: +1200)
F113+F113	S	0 (H: +170)	S	0	1) (W: +400)	S	0 (W: +400)	S	0	0	0 (W: +800)
2 x F113+F114	S	0 (H: +170)	S	0	1) (W: +400)	S	0 (W: +600)	S	0	S	0 (W: +1600)
<b>525-690 V</b>											
F19+F19	S	0 (H: +130)	S	0	1) (W: +400)	S	0 (W: +400)	S	0	0 (W: +400)	0 (W: +600)
F110+F110	S	0 (H: +130)	S	0	1) (W: +400)	S	0 (W: +400)	S	0	0 (W: +400)	0 (W: +600)
2 x F110+F112	S	0 (H: +130)	S	0	1) (W: +400)	S	0 (W: +400)	S	0	0 (W: +400)	0 (W: +1200)
F113+F113	S	0 (H: +170)	S	0	1) (W: +400)	S	0 (W: +400)	S	0	0	0 (W: +800)
2 x F113+F114	S	0 (H: +170)	S	0	1) (W: +400)	S	0 (W: +600)	S	0	S	0 (W: +1600)

1) Contact factory S = Standard 0 = Optional

The Vacon DriveSynch is a new, innovative control concept for running standard drives in parallel to control high-power AC motors. This concept suits high-power single or multiple winding motors typically above 1 MW.

### High-power AC drives up to 5 MW can be built using standard drive components with the following benefits:

- System is modular and easy to extend
- High total power can be obtained combining smaller drives
- The redundancy of the system is higher than in a conventional drive because each unit can be run independently
- The small size of the individual drive makes it easy to maintain and service
- Identical individual units reduce the required amount of spare parts and costs
- No special skills are required for engineering, installation, commissioning and maintenance of high-power drives as they are made from standard low-power modules
- Du/dt filter at the output of each individual unit ensures load balancing
- Can also run multiple winding motors with a phase shift between the windings

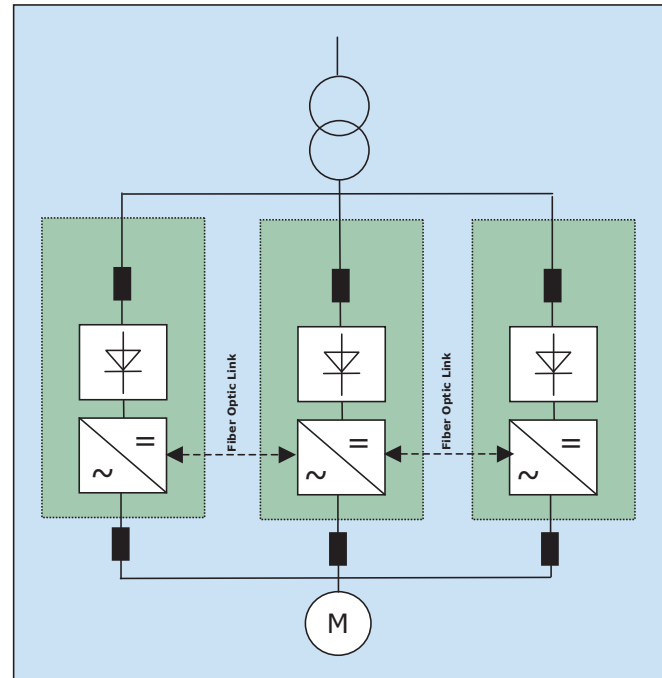

### Mains voltage 380—500 V, 50/60 Hz

AC drive type	Loadability					Motor shaft power			Frame size	Dimensions and weight W*H*D (mm)/ kg
	Low (+40°C)		High (+40°C)		Maximum current $I_S$ (A)	400 V supply				
	Rated continuous current $I_L$ (A)	10% overload current (A)	Rated continuous current $I_H$ (A)	50% overload current (A)		10% overload P (kW)	50% overload P (kW)			
2 x NXC 1150 5 A 2 L 0 SSF	2150	2365	1940	2910	3492	1200	1100	2 x FR13	2x[1406*2275*605/1250]	
2 x NXC 1300 5 A 2 L 0 SSF	2470	2717	2185	3278	3933	1350	1100	2 x FR13	2x[1606*2275*605/1350]	
2 x NXC 1450 5 A 2 L 0 SSF	2755	3031	2470	3705	4446	1500	1350	2 x FR13	2x[1606*2275*605/1350]	
3 x NXC 1150 5 A 2 L 0 SSF	3278	3605	2936	4403	5284	1800	1500	3 x FR13	3x[1406*2275*605/1250]	
3 x NXC 1300 5 A 2 L 0 SSF	3705	4076	3278	4916	5900	2000	1800	3 x FR13	3x[1606*2275*605/1350]	
3 x NXC 1450 5 A 2 L 0 SSF	4133	4546	3705	5558	6669	2250	2000	3 x FR13	3x[1606*2275*605/1350]	

### Mains voltage 500—690 V, 50/60 Hz

AC drive type	Loadability					Motor shaft power			Frame size	Dimensions and weight W*H*D (mm)/ kg
	Low (+40°C)		High (+40°C)		Maximum current $I_S$ (A)	690 V supply				
	Rated continuous current $I_L$ (A)	10% overload current (A)	Rated continuous current $I_H$ (A)	50% overload current (A)		10% overload P (kW)	50% overload P (kW)			
2 x NXC 0920 6 A 2 L 0 SSF	1748	1923	1558	2337	2679	1700	1400	2 x FR13	2x[1406*2275*605/1250]	
2 x NXC 1030 6 A 2 L 0 SSF	1900	2090	1500	2250	2700	1800	1500	2 x FR13	2x[1406*2275*605/1250]	
2 x NXC 1180 6 A 2 L 0 SSF#	2250	2475	1900	2782	3335	2000	1800	2 x FR13	2x[1406*2275*605/1250]	
3 x NXC 0920 6 A 2 L 0 SSF	2622	2884	2337	3506	4019	2500	2000	3 x FR13	3x[1406*2275*605/1250]	
3 x NXC 1030 6 A 2 L 0 SSF	2936	3229	2622	3933	5002	2800	2500	3 x FR13	3x[1406*2275*605/1250]	
3 x NXC 1180 6 A 2 L 0 SSF#	3363	3699	2936	4170	5002	3200	2800	3 x FR13	3x[1406*2275*605/1250]	

# max. ambient temperature of 35°C

# VACON NXP CONTROL

The Vacon NXP offers a high-performance control platform for all demanding drive applications. There are five slots (A, B, C, D and E) for I/O boards, and a suitable board can be selected for each slot (see table below).

An external +24 V supply option enables communication with the control unit even if the main supply is switched off (e.g. for fieldbus communication and parameter setting).

The Vacon NXP supports both **induction motors** and **permanent magnet motors** in open and closed loop control modes. The Vacon NXP also supports special motors such as **high-speed** motors.

For a closed loop control encoder, feedback from an incremental pulse encoder is normally used. It is also possible to use absolute encoders, since the Vacon NXP is available with EnDat, SSI and resolver interfaces.

Fast drive-to-drive communication is possible using Vacon's fast SystemBus fiber optic communication.



## OPTION BOARDS

Type	Card slot					I / O signal																	Note						
	A	B	C	D	E	DI	DO	DI	AI	AI	AO	AO	RO	RO	+10V <sub>ref</sub>	Therm	+24V/EXT	pt100	42-240 VAC input	DI/DO (10...24V)	DI/DO (RS422)	DI 1Vp-p		Resolver	Out +5V/ +15V/ +24V	Out +15V/ +24V	Out +5V/ +12V/ +15V		
<b>Basic I/O cards (OPT-A)</b>																													
OPT-A1						6	1	2		1					1		2												
OPT-A2													2																
OPT-A3													1	1		1													
OPT-A4						2																3/0			1				
OPT-A5						2																							
OPT-A7																													
OPT-A8						6	1	2		1					1		2												2 enc. input + 1 enc. output 1)
OPT-A9						6	1	2		1					1		2												2.5 mm <sup>2</sup> terminals
OPT-AE							2															3/0				1			DO = Divider+Direction
OPT-AF						2							2			1													EN954-1, cat 3 / ATEX therm.
OPT-AK																								3		1			Sin/Cos/ Marker
<b>I/O expander cards (OPT-B)</b>																													
OPT-B1							6										1												Selectable DI/DO
OPT-B2													1	1		1													
OPT-B4									1		2						1												2)
OPT-B5																													
OPT-B8																													
OPT-B9																													
OPT-BB						2																							
OPT-BB						2																							1
OPT-BC																													Sin/Cos + EnDat
OPT-BC																													Encoder out = Resolver simulation
OPT-BE																													EnDat/SSI
<b>Fieldbus cards (OPT-C)</b>																													
OPT-C2																													Modbus, N2
OPT-C3																													
OPT-C4																													
OPT-C5																													
OPT-C6																													
OPT-C7																													
OPT-C8																													Modbus, N2
OPT-CF																													
OPT-CG																													
OPT-CI																													
OPT-CJ																													
OPT-CJ																													
<b>Communication cards (OPT-D)</b>																													
OPT-D1																													
OPT-D2																													
OPT-D3																													
OPT-D6																													
OPT-D7																													

NOTES: Allowed slots for the board are marked in blue. 1) analogue signals galvanically isolated as a group 2) analogue signals galvanically isolated separately



## OPT-A1

Terminal	Default settings	Programmable
1 +10V	Reference voltage	
2 AI1+	Frequency reference 0–10 V	-10–+10 V, 0/4–20 mA
3 AI1-	AI common (GND)	Differential
4 AI2+	Frequency reference 4–20 mA	0–20mA, 0/-10 V–10 V
5 AI2-	AI common (differential)	GND
6 +24V	Control supply (bidirectional)	
7 GND	I/O Ground	
8 DIN1	Start forward	Many possibilities
9 DIN2	Start reverse	Many possibilities
10 DIN3	External fault input	Many possibilities
11 CMA	Common for DIN1 - DIN3 (GND)	Floating
12 +24V	Control supply (bidirectional)	
13 GND	I/O Ground	
14 DIN4	Multi-step speed select 1	Many possibilities
15 DIN5	Multi-step speed select 2	Many possibilities
16 DIN6	Fault reset	Many possibilities
17 CMB	Common for DIN4 - DIN6 (GND)	Floating
18 AO1+	Output frequency (0–20 mA)	Many possibilities
19 AO1-	AO common (GND)	4–20 mA, 0–10 V
20 DO1	READY, $I \leq 50$ mA, $U \leq 48$ VDC	Many possibilities

## OPT-A2

Terminal	Default settings	Programmable
21 R01		
22 R01	RUN	Many possibilities
23 R01		
24 R02		
25 R02	FAULT	Many possibilities
26 R02		

## OPT-A3 (alternative)

Terminal	Default settings	Programmable
21 R01		
22 R01	RUN	Many possibilities
23 R01		
25 R02	FAULT	Many possibilities
26 R02		
28 TI1+	Thermistor	Warning
29 TI1-	input FAULT	No response

Default settings of OPT-A1, OPT-A2 and OPT-A3 for the Basic and Standard Applications.

## OPT-A4 (encoder input example)

Terminal	Technical information
1 DIC1A+	Pulse input A
2 DIC1A-	
3 DIC2B+	Pulse input B; Phase shift of 90 degrees compared to pulse input A
4 DIC2B-	
5 DIC3Z+	Pulse input Z; one pulse per revolution
6 DIC3Z-	
7 ENC1Q	Qualifier input
8 DIC4	Fast DI
9 GND	Ground for control and inputs ENC1Q and DIC4
10 +5V/+15V/+24V	Control voltage (auxiliary voltage) output to encoder: Output voltage selectable with jumper X4.

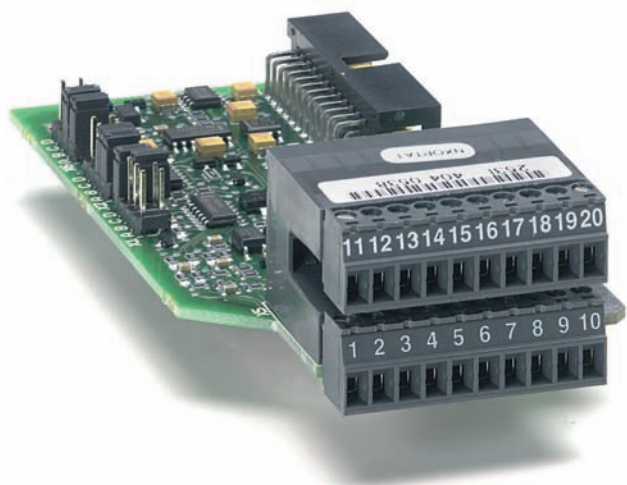

# FIRST-CLASS USABILITY



The text display with functions such as multi-monitoring, parameter copy, parameter backup and start-up wizard makes commissioning as easy as possible.

Vacon PC tools can be downloaded from the Vacon website at <http://www.vacon.com>. They include:

- **Vacon NCDrive** for setting, copying, storing, printing, monitoring and controlling parameters
- **Vacon NCLoad** for updating software and uploading special software to the drive
- **Vacon NC61131-3 Engineering** is available for making tailor-made software. A license key and training are required.

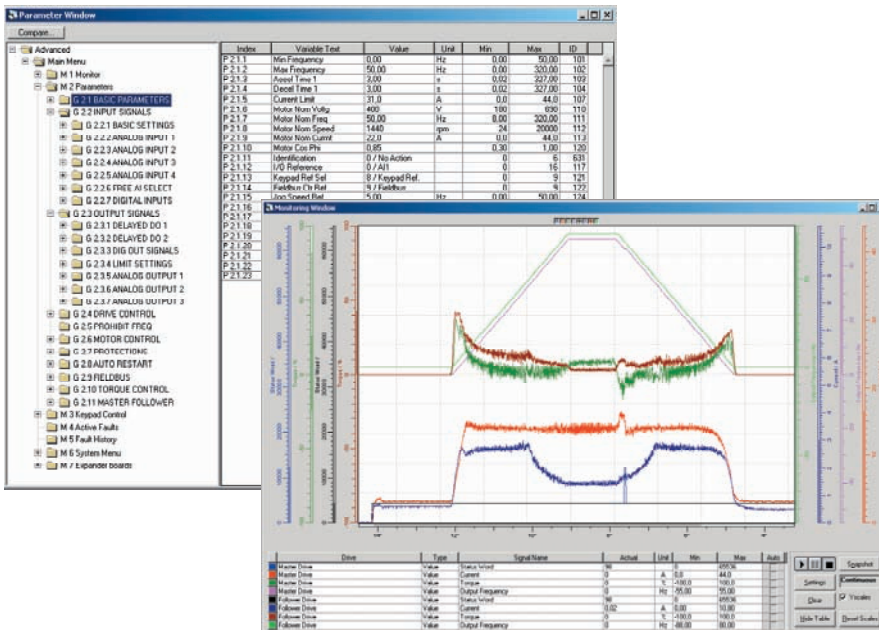

The Vacon NCDrive communicates with the drive via the following interfaces:

- RS-232
- Ethernet TCP/IP
- CAN (fast multiple drive monitoring)
- CAN@Net (remote monitoring)

# PLC FUNCTIONALITY BUILT IN

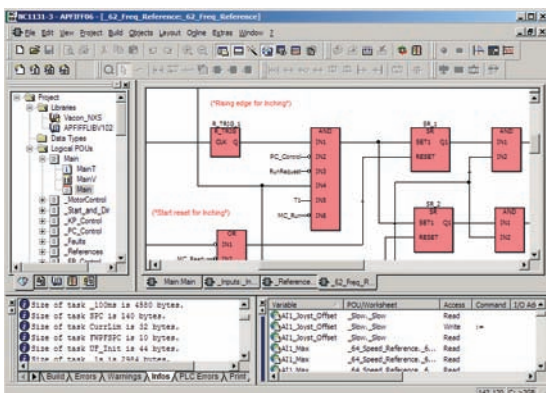

The Vacon NXP features built-in PLC functionality without the need for any additional hardware. Vacon NC61131-3 Engineering can be used to improve performance and bring cost savings by integrating customer-specific functionality into the drive.

## SOFTWARE MODULARITY

The All-in-One application package has seven built-in software applications (=default settings and functionality of control inputs and outputs) which can be selected with one parameter.

Which software application to use is asked by the Start-up Wizard at the first power-up. With this single setting, the drive can be programmed for example for two external control places or pressure control with an integrated PID controller.

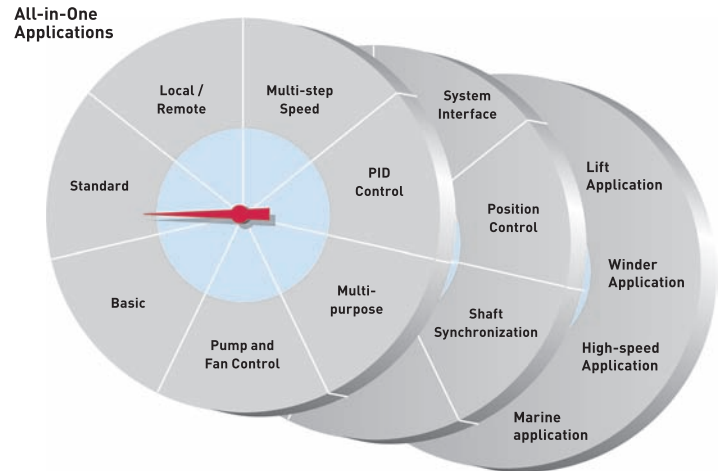

## VACON NXP APPLICATIONS

Instead of the default All-in-One application package, the Vacon NXP can also be equipped with advanced application software. This is designed to meet the requirements of demanding automation applications.

### System Interface Application

The System Interface Application is designed to provide a logical, flexible interface to machine controllers for use in demanding automation applications.

- Flexible fieldbus process data connections
- Flexible speed and torque reference chains
- Adaptive speed controller
- Inertia compensation and oscillation damping features
- Fast drive-to-drive communication for master-follower applications
- Supports permanent magnet motors
- Integrated mechanical brake and motor fan control
- Emergency stop with separate ramp time

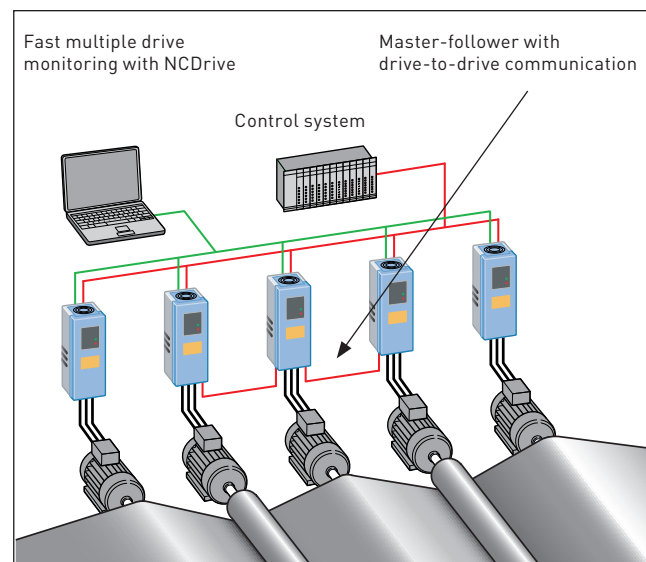

# VACON NXP APPLICATIONS

## Position Control Application

The Position Control Application offers an integrated single-axis interpolating positioning controller for the Vacon NXP.

- User-specified units for positions
- Alternative zero calibration cycles
- Home position
- Absolute and relative positioning
- Sequencing
- Hardware or software based end limits

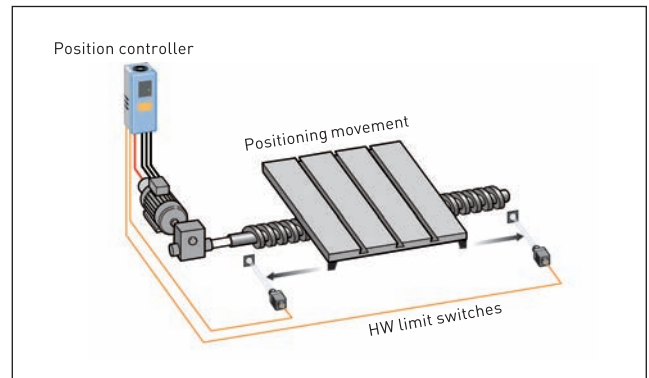

## Shaft Synchronization Application

The Shaft Synchronization Application controls the position or the angle of the follower axis directly or in an adjustable ratio to the master axis.

- Master position from secondary encoder input
- Follower position from incremental encoder or resolver
- Adjustable gear ratio
- Trim +/- inputs for ratio change during run

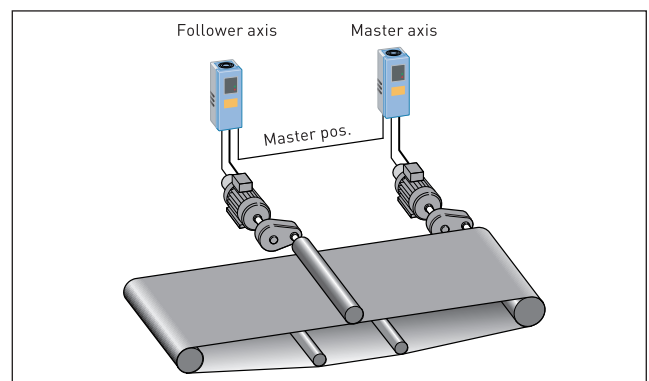

## Lift Application

The Lift Application offers ready-made lift functions for easy commissioning and tuning of a lift.

- Induction and permanent magnet motor support
- Lift speed parameters in [Hz] and [m/s]
- Integrated lift brake control logic
- Lift evacuation feature. In case of power failure, the lift can be run to the next floor.
- In-built motor contactor control logic

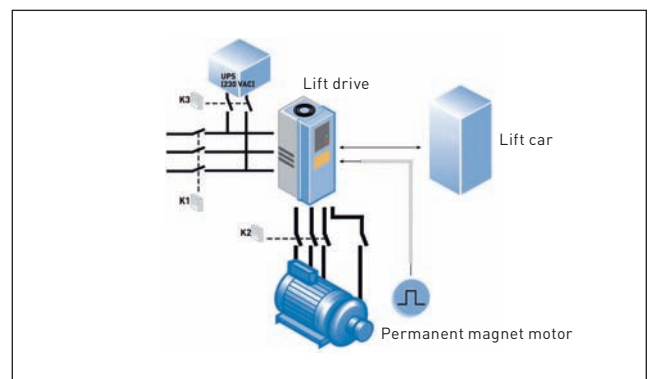

## High Speed Application

The High Speed Application allows the Vacon NXP to be used with high-speed motors, e.g. in turbo compressors and high-speed spindles.

- Induction and permanent magnet motor control
- Ready tested solutions up to 7200 Hz
- Proven technology for low motor noise and less losses
- Easy commissioning with standard hardware and software

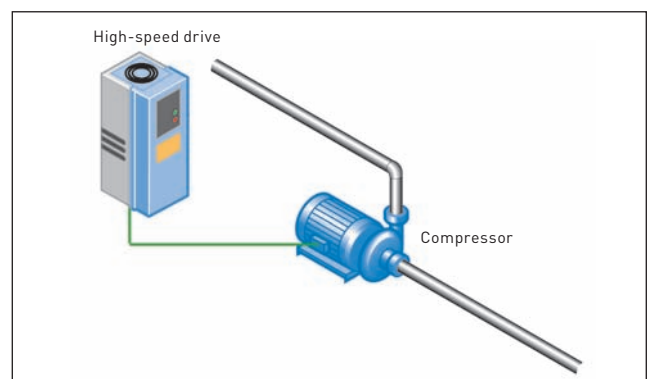

# VACON NXP APPLICATIONS

## Marine Application

The Marine Application adds support for marine specific functionality that simplifies the use of the drive in marine systems.

- Fast drive-to-drive communication for speed / load share
- Black out prevention using fast power limit control
- Full speed and constant power mode control
- Temperature measurement using PT100 sensors
- Built-in brake control logic for winches
- Load drooping

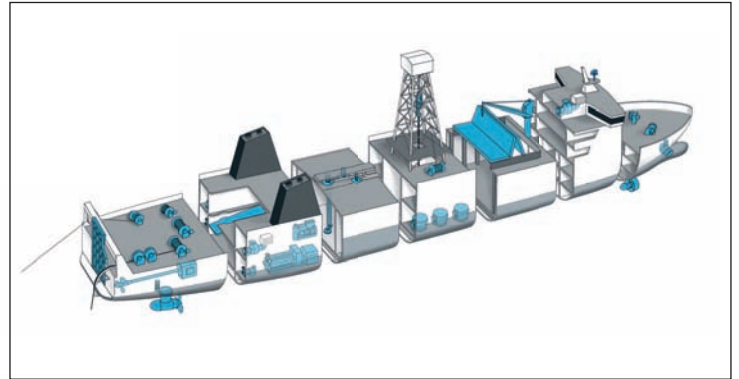

## FUNCTIONAL SAFETY INTEGRATED

The Vacon NXP can help to increase the safety of a system and reduce complexity by offering integrated safety-related functions in the drive, reducing the need for external components and wiring.

### Safe disable

The function is intended for use where there is a need to ensure that the motor will not be driven by the drive, ie. for safe standstill, for example when there is a need to perform mechanical maintenance on a machine. In such installations the function may be used to replace mechanical power switches. The function is certified in accordance with EN954-1, Cat 3.

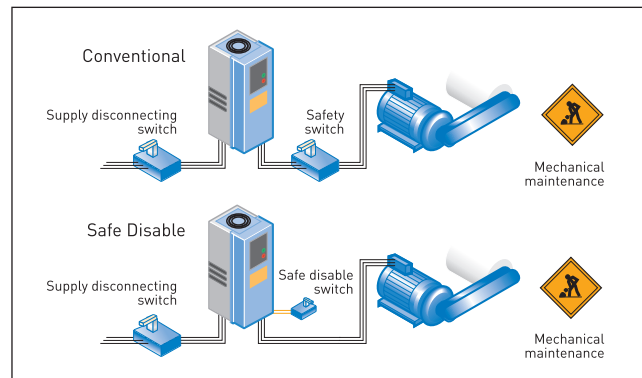

### ATEX-certified motor thermal supervision

The ATEX-certified thermistor input of the Vacon NXP is certified for use in supervising the temperature of Ex motors located in potentially explosive areas. The integrated function offers cost savings compared to conventional solutions with external thermistor relays and contactors. The thermal supervision input is certified to be compliant with the ATEX 94/9/EC directive.

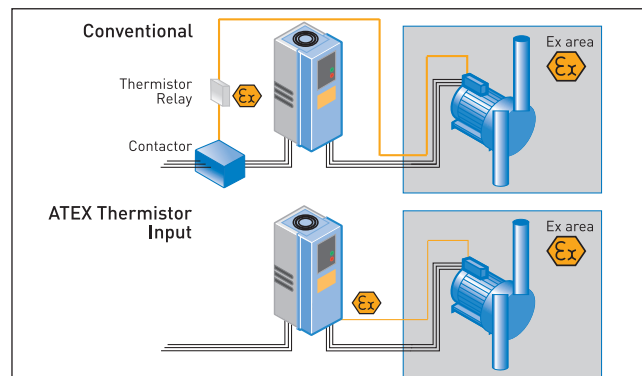

# EMC AND INSTALLATION ENVIRONMENT

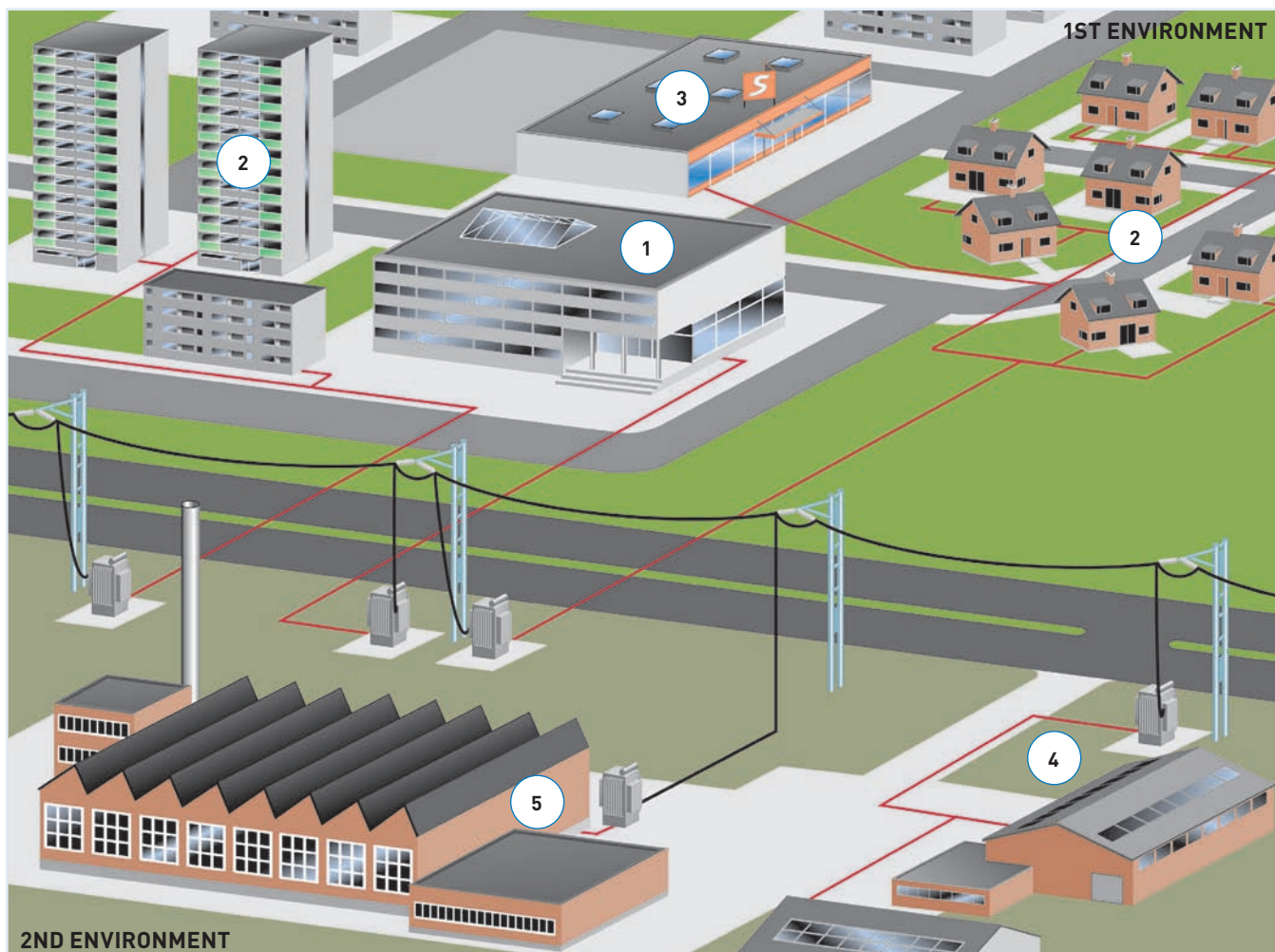

The product family standard EN61800-3 sets limits for both emissions and immunity to radio frequency disturbances. The environment has been divided into the first and second environments, in practice, public and industrial networks, respectively.

Radio Frequency Interference (RFI) filters are typically required to meet the EN61800-3 standard. These filters are integrated in the Vacon NXP as standard.

The 208–240 V and 380–500 V ranges of the Vacon NXP (FR4–FR9) meet the requirements of the first and second environments (H level: EN61800-3(2004), category C2). No additional RFI filters or cabinets are required. The FR10–FR14 and the 500–690 V ranges of the Vacon NXP meet the requirements of the second environment (L-level: EN61800-3(2004), category C3).

The units in the frame sizes FR4, FR5 and FR6 (with a voltage range from 380 to 500 V) are also available with extremely low-emission integrated EMC filters (C level: EN61800-3 (2004), category C1). This is sometimes required in very sensitive locations such as hospitals.

## EMC Selection Table, restricted distribution

	①	②	③	④	⑤	
Vacon NXP EMC	Hospital	Residential Area	Commercial	Light Industry Area	Heavy Industry	Marine
C	O					
H	R	R	R	O	O	
L				R	R	
T					R (IT Network)	R (IT Network)

R = Required ; O = Optional

<b>Mains connection</b>	Input voltage $U_{in}$	208...240 V; 380...500 V; 500...690 V; -10%...+10% NXC regenerative low-harmonic drive 525-690 V; -10%...+10%
	Input frequency	45...66 Hz
	Connection to mains	Once per minute or less (normal case)
<b>Motor connection</b>	Output voltage	0— $U_{in}$
	Continuous output current	High overloadability: $I_H$ , ambient temperature max. +50°C ( $\geq FR10 + 40^\circ C$ ) Low overloadability: $I_L$ , ambient temperature max. +40°C
	Overloadability	High: $1.5 \times I_H$ (1 min/10 min), Low: $1.1 \times I_L$ (1 min/10 min)
	Max. starting current	$I_s$ for 2 s every 20 s
	Output frequency	0...320 Hz; up to 7200 Hz with special software
<b>Control characteristics</b>	Control performance	Open loop vector control (5-150% of base speed): speed control 0.5%, dynamic 0.3%/sec, torque lin. <2%, torque rise time ~5 ms Closed loop vector control (entire speed range): speed control 0.01%, dynamic 0.2%/sec, torque lin. <2%, torque rise time ~2 ms
	Switching frequency	NX_2/ Up to and including NX_0061: NX_5: 1...16 kHz; Factory default 10 kHz From NX_0072: 1...10 kHz; Factory default 3.6 kHz NX_6: 1...6 kHz; Factory default 1.5 kHz
	Field weakening point	8...320 Hz
	Acceleration time	0...3000 sec
	Deceleration time	0...3000 sec
	Braking	DC brake: $30\% \cdot T_N$ (without brake resistor), flux braking
	<b>Ambient conditions</b>	Ambient operating temperature
Storage temperature		-40°C...+70°C
Relative humidity		0 to 95% RH, non-condensing, non-corrosive, no dripping water
Air quality: - chemical vapours - mechanical particles		IEC 721-3-3, unit in operation, class 3C2 IEC 721-3-3, unit in operation, class 3S2
Altitude		100% load capacity (no derating) up to 1000 m 1% derating for each 100 m above 1000 m; max. 3000 m (690 V max. 2000 m)
Vibration EN50178/EN60068-2-6		5...150 Hz: Displacement amplitude 1 mm (peak) at 5...15.8 Hz ( $\geq FR10$ : 0.25 mm (peak) at 5...31 Hz) Max acceleration amplitude 1 G at 15.8...150 Hz ( $\geq FR10$ : 1 G at 31...150 Hz)
Shock EN50178, EN60068-2-27		UPS Drop Test (for applicable UPS weights) Storage and shipping: max 15 G, 11 ms (in package)
<b>EMC</b>	Immunity	Fulfil all EMC immunity requirements
	Emissions	<b>EMC level C:</b> EN61800-3 (2004), category C1 <b>EMC level H:</b> EN61800-3 (2004), category C2 <b>EMC level L:</b> EN61800-3 (2004), category C3 <b>EMC level T:</b> Low earth-current solution suitable for IT networks, EN61800-3 (2004), category C4 (can be modified from L/H-level units)
<b>Safety</b>		EN 50178 (1997), EN 60204-1 (1996), EN 60950 (2000, 3rd edition) (as relevant), IEC 61800-5, CE, UL, CUL; [see unit nameplate for more detailed approvals]
<b>Control connections (OPT-A1, -A2 or OPT-A1, -A3)</b>	Analogue input voltage	0...+10 V (-10 V...+10 V joystick control), $R_i = 200 \text{ k}\Omega$ , resolution 0.1%, accuracy $\pm 1\%$
	Analogue input current	0(4)...20 mA, $R_i = 250 \text{ }\Omega$ differential, resolution 0.1%, accuracy $\pm 1\%$
	Digital inputs	6, positive or negative logic; 18...30 VDC
	Auxiliary voltage	+24 V, $\pm 15\%$ , max. 250 mA
	Output reference voltage	+10 V, +3%, max. load 10 mA
	Analogue output	0(4)...20 mA; $R_L$ max. 500 $\Omega$ , resolution 10 bit, accuracy $\pm 2\%$
	Digital output	Open collector output, 50 mA/48 V
	Relay outputs	2 programmable change-over (NO/NC) relay outputs (OPT-A3: NO/NC+NO) Switching capacity: 24 VDC/8 A, 250 VAC/8 A, 125 VDC/0.4 A. Min. switching load: 5 V/10 mA
Thermistor input (OPT-A3)	Galvanically isolated, $R_{trip} = 4.7 \text{ k}\Omega$	
<b>Protections</b>		Overvoltage, undervoltage, earth fault, mains supervision, motor phase supervision, overcurrent, unit overtemperature, motor overload, motor stall, motor underload, short-circuit of +24 V and +10 V reference voltages



**Vacon Plc**

Runsorintie 7, 65380 Vaasa, Finland  
Tel. +358 (0)201 2121, Fax +358 (0)201 212 205  
[www.vacon.com](http://www.vacon.com), e-mail: [info@vacon.com](mailto:info@vacon.com)

Vacon Partner